

University of Groningen

Pyrolysis oil upgrading to transportation fuels by catalytic hydrotreatment

Wildschut, Jelle

IMPORTANT NOTE: You are advised to consult the publisher's version (publisher's PDF) if you wish to cite from it. Please check the document version below.

Document Version

Publisher's PDF, also known as Version of record

Publication date:

2009

[Link to publication in University of Groningen/UMCG research database](#)

Citation for published version (APA):

Wildschut, J. (2009). *Pyrolysis oil upgrading to transportation fuels by catalytic hydrotreatment*. Groningen: s.n.

Copyright

Other than for strictly personal use, it is not permitted to download or to forward/distribute the text or part of it without the consent of the author(s) and/or copyright holder(s), unless the work is under an open content license (like Creative Commons).

Take-down policy

If you believe that this document breaches copyright please contact us providing details, and we will remove access to the work immediately and investigate your claim.

Downloaded from the University of Groningen/UMCG research database (Pure): <http://www.rug.nl/research/portal>. For technical reasons the number of authors shown on this cover page is limited to 10 maximum.

Chapter 1: An Introduction to the Hydroprocessing of Biomass Derived Pyrolysis oil

Abstract

An introduction to the hydrotreatment of pyrolysis oil is given and the outline of the thesis.

1. Introduction

Environmental concerns and possible future shortages have boosted research on alternatives for fossil derived products. Biomass is considered a promising alternative. It has a worldwide abundance and is considered a renewable feed. Despite the complexity associated with biomass as a feed for bio-fuels, the use of biomass is rapidly expanding. Several industries have commercialized the production of so-called first generation bio-fuels, bio-ethanol from sugar-like products (sugar, starch, etc), and bio-diesel (from rapeseed, sunflowers etc.) [1]. The scale of production of these first generation biofuels appears to be several dozens lower than typical unit operation in refineries (100 MW compared to several GW's in conventional refineries). Besides, these feeds are in competition with the food industry, which may raise ethical questions as well. For this reason, research now strongly focuses on the so-called second-generation bio-fuels. Preferably these fuels are derived from (non-edible) biomass resources. Options are wood-like biomass, including forest residues, straw, aquatic biomass, industrial residues as bagasse and the like. Possible conversion technologies are the direct conversion by fermentation processes (after conversion of the cellulosic materials to low molecular weight sugars and subsequently to ethanol), gasification to produce bio-syngas for further upgrading (e.g. to methanol or gasoline and/or diesel), or liquefaction with further upgrading (either through gasification or through de-carboxylation, hydrogenation etc). Nevertheless, biomass is still not widely used for bio-fuel manufacture. The main reasons are the presence of contaminants (including ash, water and oxygen), the variation in chemical composition and its low energy density. To overcome these issues, an indirect approach seems advantageous. A possible indirect approach is a pretreatment process for the biomass to create a more uniform structure, after which secondary conversion processes transform the intermediates to a diesel- or gasoline-like product. The pretreatment technique referred to in this introduction is the (fast) pyrolysis of biomass [2]. Here the biomass is converted into a liquid product (fast pyrolysis oil or also known as bio-oil), which is to be further upgraded to a bio-fuel.

It is not the purpose of this introduction to give an extensive literature overview on pyrolysis. The interested reader is referred to reviews, papers and reports published by a.o. Bridgwater *et al.* [3,4]. Some relevant characteristics are given. Fast pyrolysis

technology involves the rapid heating of lignocellulosic biomass to temperatures in the range of 450-650 °C with a residence time of < 2 s in an oxygen free atmosphere [2]. Liquid product yields as high as 70 %-wt. have been reported [2]. The resulting oil is not directly suitable as a biofuel for internal combustion engines. It contains large amounts of water (up to 50 %-wt.) and corrosive organic acids (up to 10 %-wt.) and shows limited storage stability [5]. Therefore, upgrading by either chemical or physical methods is required [2].

From the first days of bio-oil production onwards, research was dedicated to the removal of oxygen, either by catalytic cracking or by de-oxygenation of the oil using hydrogen (similar to conventional hydro-desulphurisation processes). This process, commonly being referred to as ‘hydrodeoxygenation’, may include any reaction where hydrogen is used to transform such oils, such as hydrotreating, hydroprocessing and / or hydrocracking. The product aimed at was a transportation fuel, either diesel or gasoline.

1.1 Pyrolysis oil properties

Pyrolysis oil from biomass is typically a red-brown liquid with a pungent odour, with physical properties as shown in Table 1 below. The oil contains the de-fragmented parts of the oxygenated components of the original biomass structure (mainly cellulose, hemicellulose and lignin). The oil contains up to 35 to 45 %-wt. oxygen on a dry basis. The oil has a relatively low heating value with respect to fossil fuels (the oil is partially combusted), is acidic (pH~3), is relatively polar and thermally rather unstable, leading to limited storage stability.

Due to the presence of large amount of (potentially) highly reactive components, the oil is unstable and tends to phase separate and form solids upon storage. Phase separation is promoted by higher temperatures and appears to be faster when the amount of water in the oil is low. Severe polymerization of the oil will result in the formation of char (‘charring’). Distillation (even under vacuum) also causes undesirable chemical changes leading to the formation of large amounts of solid material.

Table 1. Pyrolysis oil properties [5-7].

Property	Value
Density (kg/l)	1.15-1.2
Viscosity (cP) at 40 °C	40-100
Water content (%-wt.)	20-30
Acidity (pH)	2-3
Flash point (°C)	40-65
Elemental composition (%-wt.)	
C	~52
H	~6.4
O	~40
N	~0.2
Ash content (%-wt.)	0.1
Heating value (MJ/kg) LHV	13-19

The oil itself is a complex mixture of components and is difficult to analyze and characterize. The following classes of chemicals present in the oil have been reported (Oasmaa *et al.* [8,9]):

- water
- water solubles (acids, alcohols)
- ether solubles (aldehydes, ketones, lignin monomers, etc)
- ether insolubles ((anhydo)sugars, hydroxyl-acids)
- n-hexane solubles (fatty acids, extractives, etc)
- Dichloromethane (DCM) (low molecular weight lignins (LMM lignin) extractives) and
- DCM insolubles (high molecular weight lignins (HMM lignins), solids)

Especially the ether insolubles (the sugar components, a syrup-like fraction) appear to be the fraction with a high oxygen content (up to about 50 %, in comparison with the LMM and HMM lignins containing 25 to 30 % oxygen).

Characterization of bio-oil on a molecular level is mainly carried out by gas chromatography. However, this technique has a major limitation. Components that are poorly volatile, because of molecular size/ or polarity, or reactive in the injection section, will not be detected, and this fraction may be up to 30 %-wt.

The following properties need to be improved to make the oil suitable as a transportation fuel:

- Acidity needs to be reduced
- Energy density needs to be higher
- Lower viscosity
- Improved miscibility with fossil fuels
- Less formation of particulates upon heating or during storage

Hydrodeoxygenation is one of the possible upgrading technologies to achieve these objectives.

1.2 Pyrolysis oil upgrading by hydrodeoxygenation

For the hydrodeoxygenation of bio-oils, elevated temperatures and the presence of a catalyst and hydrogen are required. Early experiments showed that temperatures in the order of 300 to 400 °C are required to achieve reasonable deoxygenation activity. The presence of water in the hydrotreatment process seems crucial to avoid excessive char formation. This necessitates high pressures in order to avoid water evaporation (150 to 300 bar).

The overall reaction stoichiometry of the hydrodeoxygenation reaction may be generalized by:

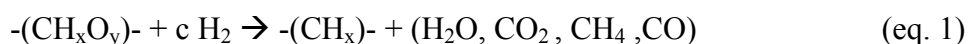

The values for x (H/C) and y (O/C) depend on feedstock, operating conditions, any further treatment methods, water content and so on. Representative values for various (dry based) oils are (x , y) = (1.4 , 0.6).

The various reaction pathways taking place during the hydrodeoxygenation process are:

1. Water separation, due to a change in molecular characteristics of bio-oil components.
2. Dehydration reactions, in which water is produced from the bio-oil due to for instance, condensation polymerization reactions.
3. Decarboxylation reaction (DCO), wherein part of the oxygen in the bio-oil is released from the oil in the form of CO₂.
4. Hydrogenation reactions, in which hydrogen reacts with unsaturated bio-oil components. Hydrogenation may involve the saturation of C-C double bonds and the addition of hydrogen to carbonyl groups to form alcohols.
5. Hydrogenolysis involving the break up of C-O bonds. In these reactions oxygen may be removed in the form of water.
6. Hydrocracking reactions, by which the molecules are broken down into smaller molecules by the active involvement of hydrogen.

Catalysts seem to be required to enable high levels of oxygen removal. It has been proven though that during heating up of bio-oil in the absence of hydrogen and/or catalysts the chemical composition of the oil changes. The latter is referred to as the high pressure thermal treatment (HPTT). In comparison with literature, HPTT has similarities with Hydrothermal Liquefaction and / or HTU [10,11,12]:

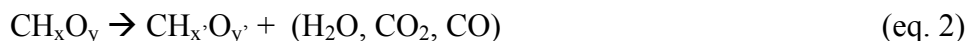

The HPTT process may include condensation polymerization, esterification, acetalization and phenol/formaldehyde type of reactions.

In the past, hydrodeoxygenation was thought to be strongly related to conventional hydrodesulphurization (HDS), and /or hydrodenitrification (HDN) processes being carried out in refinery industries. Some obvious differences can be noted as well:

1. In the HDO process, water is produced as a byproduct. This, however, together with the water already present in the bio-oil may affect catalyst performance in a

- negative manner. Typical HDS catalysts may not be suitable as they are designed for an apolar environment.
2. Higher temperatures and consequently higher (hydrogen) pressures seem required for hydrodeoxygenation to avoid excessive charring.
 3. The oxygen content in typical pyrolysis oils is much higher than the S-content in fossil feeds.
 4. HDS processes are currently tailored for deep S removal, which may not be necessary for the HDO of pyrolysis oils.

2. History of bio-oil hydrotreating

The first papers on the hydrotreating of pyrolysis oil appeared in 1984 (Elliot *et al.* [13]). In these papers, apparent similarities between HDS were taken as a starting point. The commonly applied catalysts were HDS catalysts, either NiMo/Al₂O₃ or CoMo/Al₂O₃. The most important findings from this work were that bio-oil could not be treated as such. Severe reactor blockage was observed due to charring of the bio-oil. From these experiments it appeared that a so-called stabilization step was necessary. In this step the most reactive compounds are converted to less active ones in a controlled way to avoid the severe charring afterwards in a subsequent hydrotreating step [13-16].

However, most of the early research appears phenomenological in nature and fundamental knowledge is lacking. The amount of papers known authors, in which a process engineering approach is followed with consistent conclusions is less than ten. Besides, apparent conflicting results are presented, mainly in terms of deoxygenation levels, which vary between 10 and 90 % at seemingly similar operating conditions and catalysts [13,17]. Effects of co-solvents may interfere with such experiments, but this is not yet clear. An overview of important research is given in Table 2.

Table 2. Summary of HDO of fast pyrolysis oil

Authors	Yield (%-wt.)	Deoxygenation (%-wt.)	Reactor		Catalyst	Temperature (°C)	Pressure (bar)	LHSV/ Residence time	Solvent/ additive	Remarks
			Type	Size (ml)						
Elliot, Baker (1984)	80	90-95	Bench scale continuous flow reactor	1000	NiMo and CoMo on Al ₂ O ₃	350-450	138	0.1-0.6		Various Pyrolysis oils
Gagnon, Kaliagiune (1988)	-	75	Batch slurry reactor		first 5 %-wt. Ru/Al ₂ O ₃ and then NiO-WO ₃ /Al ₂ O ₃ , CuCr	80-325	41-172	120 min		Vacuum pyrolysis oil feed. Copper chromite resulted in massive coking
Sheu, Anthony, Soltes (1988)	-	10-50	Trickle bed	157	Pt/Al ₂ O ₃ /SiO ₂ ; sulphided CoMo, NiW & NiMo	350-400	53-104	WHSV 0.5-3.0	Decalin	Flash pyrolysis oil from pine sawdust & bark
Elliott (1988)			Upflow packed bed	1000	CoMo/Al ₂ O ₃	stage 1:274; stage 2: 350-450	69-208	stage 1: LHSV =0.62; 2:LHSV=0.1		Various pyrolysis oils
Oasmaa (1992)	65	86	Batch		10 %-wt. CoO/Al ₂ O ₃	390	215	2 hours		Peat pyrolysis oil
Baldauf, Balfanz, Rupp (1994)	30-35	88-99.9	Packed bed, up- and downflow	716	CoMo, NiMo sulphided	350-370	up to 300	WHSV 0.15-0.8	DMDS, glycol	Only 30-35% yield, water main product; hardwood bio-oil, part experiments water-washed feed
		78-85	Slurry reactor	3000-12000						

Conti, Scano, Baufola, Mascia (1995)	72	60	2 Stage packed bed upflow	100; 1000	NiMo sulphided	stage 1:140, stage 2:250- 275	50	stage 1: LHSV =0.52; 2:LHSV=0.0 5		
Samolada, Baldauf, Vasalols (1998)	30-55	88-99.9	Packed bed, up- and downflow	800	NiMo, CoMo	Up to 500	Up to 325	WHSV of 6-9 and 14-19 h ⁻¹		<i>Eucalyptus</i> flash pyrolysis oil
Elliott, Neuenschwander (various)	-	31-99	2 Stage trickle bed	100; 425	NiMo, CoMo, sulphided; Ru/C and Ru/TiO ₂	150-390	75-150	LHSV 0.5- 1.5		Waterwashed and "whole" white wood, bagasse, eucalyptus, etc.
Su-Ping (2003)		90	Batch slurry reactor	500	CoMo sulphided	360-390	15-30 cold	5-60 min	Tetralin	Waterwashed bio- oil from fluidized bed reactor

2.1 Feed

The complexity of bio-oil hydrotreating starts at the very beginning: the feedstock applied to produce the bio-oil. Lignocellulosic biomass is an inhomogeneous material generally containing mixtures of carbohydrate and lignin structures. The carbohydrates are usually composed of both five - and six – carbon sugar polymers, while the lignin components are aromatic polymers of nominally propyl-methoxyphenols. In addition, there are proteins, fatty acids / oils and mineral components (ash) present as well.

Different biomass resources have different contents of above-mentioned components (Table 3). It is thus evident that oils derived from wood-like products (pine, beech, etc.) differ from those produced from straw-like products, vegetable oil containing materials, or any other feed for bio-oil production. It may be postulated here that the differences between a bio-oil derived from pine grown in Finland and the oil derived from beech in the Netherlands, are more significant than the differences in crude oils from the North Sea and Malaysia respectively. Besides, a variety of (fractions from) bio-oils have been used: earlier tests were carried out using oils derived from so-called hydrothermal liquefaction (the process referred to as the PERC process, located in Albany) [12,16], or from slow pyrolysis [16-18]. From the 1980's onwards, oils derived from fast pyrolysis were applied, originally in their pure form [13,15,19], and later after certain pretreatment steps (mild hydrotreating [20-22], or high pressure treatment without catalyst and hydrogen). These differences in oil properties due to feedstock variations are expected to have a major impact on the product properties of the hydrotreated products derived thereof.

The following observations are reported for hydrotreating pyrolysis oils obtained from different biomass sources:

- Vacuum pyrolysis oils seem somewhat more difficult to be hydrotreated than oils produced in fluid bed processes [16].
- 'Stabilized' oil shows much less charring than the pure bio-oil.
- Eucalyptus derived oils show lower de-oxygenation rates than poplar derived oils [16].

- Softwood derived oils appear to be more easily hydrogenated than bagasse-derived oil [16].
- Softwood derived oils appear to be more easily hydrogenated than hardwood derived oils [16].

Table 3. Composition of different biomass types (%-wt.) [23].

Biomass Type	Cellulose	Hemicellulose	Lignin	Extractives	Ash
Soft wood	41	24	28	2	0.4
Hard wood	39	35	20	3	0.3
Pine bark	34	16	34	14	2
Straw	40	28	17	11	7
Rice husk	30	25	12	18	16
Peat	10	32	44	11	6

2.2 Catalysts

Catalysts tested for the hydrotreatment of pyrolysis oil are those conventionally used for HDS (sulphided NiMo/Al₂O₃ and CoMo/Al₂O₃). Among these two, CoMo/Al₂O₃ catalyst seemed the best choice with respect to deoxygenation activity. Noble metal catalysts such as Ru, Pd, Rh, Pt and less obvious ones as CuCr, CuO, NiO, Ni on Mg₂O₃/SiO₂ or on activated carbon have been tested as well. In (semi-)batch set-ups the noble metal catalyst in general showed similar or even better performance than the conventional hydrotreating catalysts.

From the earlier work summarized in Table 2 it may be concluded that the conventional catalysts (sulphided NiMo/Al₂O₃ and CoMo/Al₂O₃) have been tested for a wide range of operating conditions, reactor types, feedstocks, whereas considerably less is known about the performance of noble metal catalysts. Typical conversions of bound oxygen for the conventional catalysts are in the range of 80-99 %-wt., and, of course, depend upon the severity of the process. The un-sulphided form of the catalyst showed less activity than the sulphided catalysts. This implies that the addition of a sulphur source is advantageous when using these catalysts.

Besides, the catalysts appear to become inactive after some time on stream. Values of a few hours [13,22,24] up to a few days were reported by Veba Oel [16]. Different mechanisms are proposed, a.o. blocking of catalyst pores and/or activated sites (by oil re-polymerization reactions), irreversible poisoning of the catalyst (by nitrogen compounds, water, etc), sintering of the active catalyst slabs, structural degradation (of support and of active material), coking and metal deposition [25]. Some of the deactivation issues will be discussed below in more detail.

2.2.1 Deactivation by water

In conventional HDS, the oxygen content of the feed is low in comparison with feeds from biomass. However, still some water may be produced by reactions of (small) amounts of oxygenates in the feed. It was demonstrated that water has an inhibiting effect on conventional sulphided catalysts (NiMo/Al₂O₃ and CoMo/Al₂O₃) [25]. This was confirmed by hydroprocessing water-rich oils [13,25]. A possible explanation is leaching of the sulphur on the catalyst by the action of (liquid) water. This effect may be counteracted by adding H₂S to the (sulphur free) feed.

Model study experiments also indicate that water affects the catalyst structure of conventional HDS catalysts in a negative way. Apart from changes in the chemical composition of the support (from alumina in to boehmite), a concurrent sintering of nickel was noticeable together with oxidation to either non-catalytically active nickel sulphates or aluminates [16].

2.2.2 Deactivation by coking

The main reason for deactivation of catalyst is blocking of the catalyst pores by polymerization reactions leading to coke (e.g. Baldauf *et al.* [26]; and Elliott [16]). A rapid deactivation of NiMo and CoMo catalysts was found by Gevert and Ottersted [27] during the first hours of operation, but this became steady at prolonged reaction times. Coking appears to be faster if there is any (local) depletion of hydrogen and at higher temperatures, both suggesting that during the hydrotreating process a continuous competition takes place between the hydrogenation/ hydrodeoxygenation and the coking reaction.

The extent of coking is a function of the feed (mainly the ‘charring’ characteristics), the hydroprocessing conditions, but also the structure and support of the catalyst. The coking rate appears to be reduced if the acidic oils are contacted with an acid carrier (Appelby *et al.* [28]). The commonly used alumina supports are believed to promote coke formation [25,29,30]. From model component studies it appears that at least the phenolic components are responsible for coking (Laurent *et al.* [31], Centeno *et al.* [32]).

2.2.3 Deactivation by nitrogen compounds

Due to the presence of proteins in the biomass, bio-oils can contain certain nitrogen containing compounds. The amount ranges from 0.1 %-wt. (wood) up to 3-4 %-wt. (grass). These nitrogen components are present as, or are converted during hydrotreatment to mainly ammonia, methyl amine, pyridine and methyl pyridine [5]. In the case of the NiMo/Al₂O₃ and CoMo/Al₂O₃ catalysts deactivation by nitrogen compounds may occur due to adsorption on the active acid sites as known from conventional HDS processing as well [25].

2.2.4 Deactivation by metal deposits

The coking reactions referred to above may be enhanced by (and in parallel to) deposition of (alkali-) metals. In the case of bio-oil from wood the relevant metals are calcium, potassium, iron, alumina, sodium, magnesium and silica. Calcium and magnesium were shown to have the tendency to accumulate onto the surface of NiMo/Al₂O₃ and CoMo/Al₂O₃ [25,33]. These deposits may lead to irreversible structural changes in the catalyst. The following order of deactivation has been established: Na > Ca > Mg = Fe. Serious deactivation was observed in the hydrotreating of PERC oil, which is known to contain high amounts of alkali metals [16].

2.2.5 Deactivation due to sintering

Sintering may occur at high temperatures which are inherent to conventional hydro-processes. For the HDO process, a beneficial effect of (liquid) water in the feed may be expected. Hydrotreating reactions are (strongly) exothermic. Any excess heat generated

by the reactions may be used to evaporate the water, thus allowing an easy way to avoid excessive temperature excursions.

2.3 Reagent gas

The hydrogen pressure must be sufficiently high to achieve proper deoxygenation rates. In a typical hydroprocess, unconverted hydrogen gas is recycled to the reactor. However, during hydroprocessing, substantial amounts of other gases are produced as well. Data for hydrocracking experiments show gas yields of up to 10 %-wt. of the feed. To prevent build-up of gases other than hydrogen, part of the recycle gas stream is bled.

In the hydroprocessing of bio-oil relatively large amounts of oxygenated components (CO and CO₂) are produced. Upon recycling of the reactant gas, the concentration of such 'inert' components will build up. Effects of CO and CO₂ (and other gases) on the hydrotreating activity are unknown.

2.4 Reactor configurations

2.4.1 Batch wise operation

Batch wise operated autoclave experiments were used predominantly at the start of the pyrolysis oil hydrotreating research [22]. Experiments showed that in the absence of catalysts or poorly active catalysts extensive coking of the oil can take place, also when hydrogen was supplied (e.g. Gagnon *et al* [22], Oasma *et al.* [24] and Scholze *et al.* [34]). Deoxygenation of the oil using active catalysts, down to a few percent level was reported in the nineties, but only at batch times exceeding 2 hours (Oasma *et al.* [24]).

For NiMo and CoMo) significant hydrogen uptake was observed at relatively low temperatures (< 200°C). Such a low temperature 'pretreatment step', although not suitable to achieve deep deoxygenation, appears advantageous to reduce coking at higher temperatures in the next step. This is likely because components responsible for charring at high temperatures are converted to less reactive ones. Hydrodeoxygenation of pyrolysis oil thus seems to require a two-step procedure with respect to the temperature and pressure. A first step (~250 °C and 100 bar of hydrogen pressure) may yield overall deoxygenation levels of about 50 %, but this may be due mainly to the thermal

decomposition reactions (similar to HPTT). The hydrogen consumption is reportedly due to partial hydrogenation of the reactive, smaller components such as acetaldehyde and hydroxyacetaldehyde. Acids, however, are rather inert, even for batch times up to 24 h. Deoxygenation levels exceeding 90% can be reached only at temperatures of ~ 350 °C and pressures of 200 bar, and residence times exceeding 2 h [35]. The latter indicates that the overall deoxygenation rate is relatively slow.

In 2003 the hydrodeoxygenation of pyrolysis oils dissolved in ‘inert’ liquids was reported. For instance, Zhang *et al.* [19] described the upgrading of pyrolysis oil by HDO using a CoMo/Al₂O₃ catalyst in tetralin. At 350-390 °C and 30-50 bar pressure the oxygen content in the oil decreased from 30 %-wt to ~ 5 %-wt.

2.4.2 Continuous packed bed reactors

Process and reactor assessment for continuous hydrotreatment started with continuous packed bed reactors. In the eighties, given the lack of fast pyrolysis oils, the hydrothermal liquefaction oils from the PERC process were used as the feed [16]. At that time, the two-step approach was proposed to optimize the aromatic gasoline yield. This approach included a first initial hydrotreating step, after which the produced water phase (containing some left carbon compounds) was removed and the remaining fraction was hydrocracked. Such a two-step approach resulted in a reduction of the overall hydrogen consumption and a fourfold decrease in residence time while retaining overall gasoline yield. One reason for this may be that hydrotreating the aqueous phase may result in the additional consumption of hydrogen. A similar concept was proposed for fast pyrolysis bio-oils, to avoid severe and rapid reactor plugging due to the instability of the bio-oil [16]. In this two-step approach, a first catalytic hydrogenation step was proposed at lower temperatures (up to 280 °C) to stabilize the oil. In a next step (without removing the water phase) the oil was treated at more severe conditions to remove the remaining oxygen. The first step generally results in a product with significantly lower oxygen contents of 20 to 25 %-wt. The product is reportedly thermally stabilized, as it could be distilled batch-wise without coke formation. Baldauf *et al.* [26], reported bench scale experiments where the bio-oil was preheated in the first part of a reactor filled with SiC, and hydrotreated on a standard hydrotreatment catalyst in the remaining bed at temperatures up to 370 °C and

pressures of approx. 300 bar. In this first stage, residence time and hydrogen flow played a minor role, was also demonstrated by Rep *et al.* [36] who reported similar results in the absence of catalysts and hydrogen. Sheu *et al* [17] reported the hydrotreating of slow pyrolysis oils using a co-solvent (decalin). Low de-oxygenation levels were reported (10 to 50 %), at seemingly similar operating conditions as shown in the work of Elliot, but in a single step (250 to 400 °C, and WHSV 0.5 to 3 hr⁻¹). Relevant here, however, may be the relatively low pressure of the system, ranging from 53 to 104 bar. Due to the use of a co-solvent, effects of charring may be less, but then, at the higher temperatures of 400 °C, the water will be fully evaporated. It is likely that, due to the evaporation of water, the experiments carried out are more HPTT than HDO alike. This is supported by the experimental results as well, as the space velocity was not shown to have a significant effect on the deoxygenation level, while a pressure increase reduced coke formation.

The Koehleel process, with the so-called Integrated Gross Oil Refining (IGOR⁺) technology, was successfully applied by DMT to upgrade Union Fenosa bio-oils [37]. A process flow sheet of the pilot plant configuration is given in Figure 1. The feed is homogenized and a powdered catalyst (sulphided NiMo, < 0.1 mm) is added. The suspension is then compressed together with (recycled) hydrogen to 300 bar and pumped into a liquid phase reactor at 375 °C. The liquid is separated from the solids and is fed over a second bed with a similar type of catalyst (> 2.5 mm). Here the vaporous liquid is hydrogenated further at 380 °C. The product from this vessel is condensed to 290 °C, and the liquid fraction is (partially) returned to the second reactor. The gaseous fraction is further hydrogenated in a third reactor, where light and medium oils are separated. The hydrogen-rich residual gas is recycled back to the reactors. The process differs considerably from other research in the sense that any coking taken into account in the first reactor where the solid particles are removed, while exothermic effects and further charring are controlled by dilution of the reactive components by recycling a part of the hydrogenated oils.

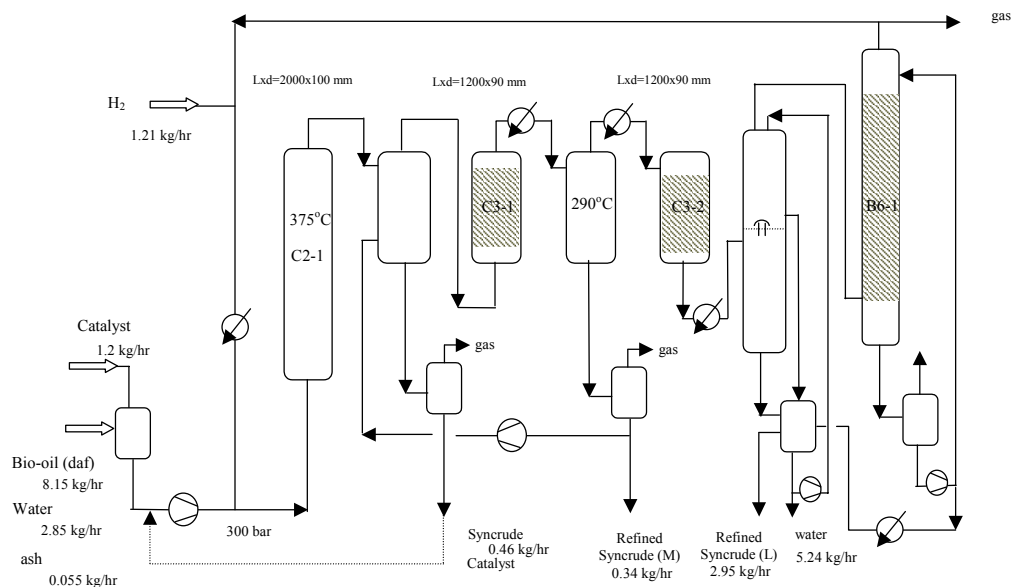

Figure 1. Pilot plant lay-out and approximate flow rates and operating conditions for the hydrotreating experiments in the IGOR⁺ process

The following observations on reactor performance are of interest:

1. The reactor configuration (up or down flow) has an effect on the plugging tendency during reaction. Down flow appears to be better than up flow operation [16].
2. At similar operating conditions, de-oxygenation in up flow is less than in down-flow mode [26]. This may be due to poor contact between oil, catalyst and/or hydrogen in the up-flow mode.
3. Dilution of the bed with an inert material leads to much higher reaction rates per unit of catalyst. The exact reason for this observation is not known but may be associated with either the chemistry or the hydrodynamics of the system.
4. To the best of our knowledge the exothermicity of the hydrodeoxygenation / hydrogenation reactions has not been taken into account. On the basis of simple thermodynamic calculations, an average overall heat of reaction of about 2.4 MJ/kg oil was obtained. In comparison, in HDS with a 0.1 %-wt. sulphur in the feed, a reactor bed temperature increase of several tenth degrees of celcius is commonly observed, necessitating intermediate quenching of the gas [29,38].

5. Various researchers show that an initial mild hydrotreatment step at temperatures as low as 80 °C renders an intermediate product (with a lower molecular weight), that is more readily hydrotreated to lower oxygen content [16,22,24].
6. A few reports on the use of a solvent (usually considered to be a hydrogen donor solvent) mixed with the original feed have been published [19]. Such a solvent may lead to a marked improvement of the quality of the product, and the catalysts seem less deactivated by coke deposition [16,17,19,39]. Coke formation is expected to have an order higher than one in active components [17]. To reduce the effect of charring, the local concentration of active components thus has to be as low as possible. This is obtained by diluting the bio-oil with a (less-reactive) component, and may be the reason for the positive results derived by researchers using a co-solvent such as tetralin [19,39,40] or decalin [17].
7. Hydrogen is not readily soluble in water (or polar) components. Hydrogen solubility in bio-oil is reportedly similar to that in water. Only when the bio-oil becomes less polar, the hydrogen solubility increases rapidly.
8. Although work on model components show that phenols are converted very rapidly and at low temperatures already, severe hydrotreating of bio-oil still reveals the presence of phenols. This may indicate that during the hydrotreating process the phenolic fraction is consumed but also continuously produced due to e.g. lignin depolymerisation reactions.

3. Product properties of hydrotreated fast pyrolysis oil

3.1 Introduction

Product properties of HDO oil reported in the literature are scarce, despite the necessity to compare it with crude oil standards. Actually there is no standard for the analysis of bio-oils and HDO oils. Literature data still mainly concentrate on the ‘macro properties’ of the products instead of its molecular properties.

3.2 Product properties

To be used as a transportation fuel, the HDO products should fulfil a number of properties. When aiming at complete deoxygenation and thus the synthesis of a

hydrocarbon product, the product properties have to fulfil those of typical gasoline and diesel products. However, products with a certain oxygen content may still be attractive biofuels. For these, no standards are available yet, though some general remarks may be given here. Properties of particular interest and to be considered are:

- Oxygen content
- Water content
- Viscosity
- Organic acid content
- Coking tendency
- Solids content
- Flash points
- Cold flow properties (pour and cloud point)
- Storage stability

These properties may be measured using standardized procedures. Some relations between these properties have been observed. For instance, the viscosity of the product is a function of oxygen content. Figure 2 shows the relation between the oxygen content and the viscosity of the product. At high oxygen contents the oil contains substantial amounts of water, rendering the oil in to a relatively low viscosity product (20 – 50 cps at 20 °C). However, upon oxygen removal (and consequently phase separation of the oil), the viscosity increases drastically (up to 100,000 cps at 20 °C). The highest viscosity is observed at an oxygen content between 20-30 %. Product with a lower oxygen content than the maximum again have a lower viscosity, ultimately reaching the value for hydrocarbons (around 1 cSt at 20 °C).

Currently, there is a large interest in identification of individual components or classes of components by dedicated analytical techniques. However, this work is seriously hampered by the diversity of components with a broad range of molecular weights in the (upgraded) oils. One technique is often not sufficient to characterize the full matrix and a combination of techniques is required to get insights in the molecular composition.

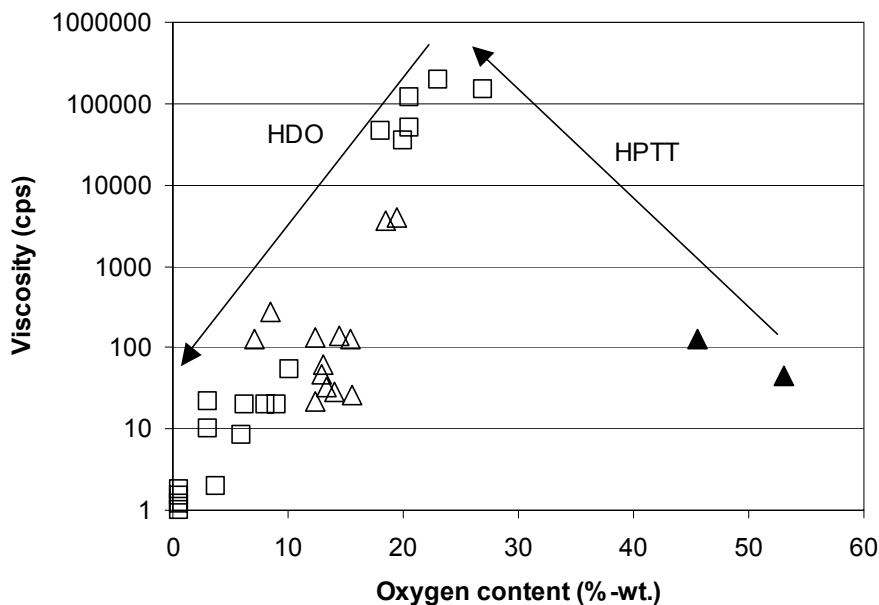

Figure 2. Viscosity versus oxygen content for data adapted from Elliott *et al* [20], [41].

A solution is characterization by dividing the bio-oil and HDO oils into several fractions. A first approach was undertaken by Sheu *et al.* [17,42], who classified the products from hydrotreating experiments in terms of fractions derived from size exclusion chromatography combined with GC. The fractions were labelled as the heavy non-volatiles, the light non-volatiles, phenols, aromatics, alkanes and a mixture of (coke, water and gas).

VTT characterized oils using a solvent fractionation scheme [9,43]. This method successfully enables the observation of major chemical changes in the oils. The scheme is summarized in Figure 3. The fractions are labelled extractives, the ether solubles and insolubles, DCM solubles and DCM insolubles. All fractions are enriched in certain component classes. For the components present in these individual fractions, the reader is referred to Oasmaa *et al.* [9,43].

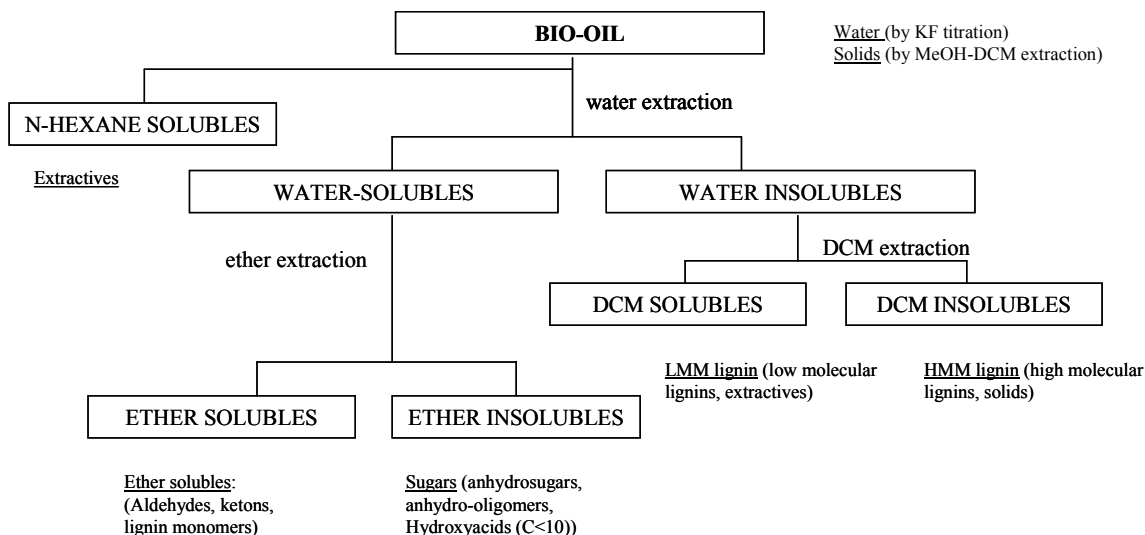

Figure 3. Fractionation scheme adapted from Oasmaa [9,43].

3.2 Product representation: the Van Krevelen diagram

An essential parameter for bio-oil and hydrotreated products is the elemental composition in terms of carbon, hydrogen and oxygen. A useful way to compare various products is the traditional Van Krevelen diagram [44], in which the ratio between O/C and H/C of the products are plotted. An example of such a plot is given in Figure 4. In this plot, various products are shown ranging from methanol ((H/C,O/C) = (4,1)), methane (4,0), to various biomass sources (1.4-1.7,0.5-0.8), pyrolysis oils (1.7,0.6) and oils from high pressure thermal treating of biomass (1.2,0.13-0.25). The objective in previous HDO research was to obtain a hydrocarbon product with an oxygen content close to zero and a H/C ratio of 1.5 to 2, the latter being typical for diesel/gasoline.

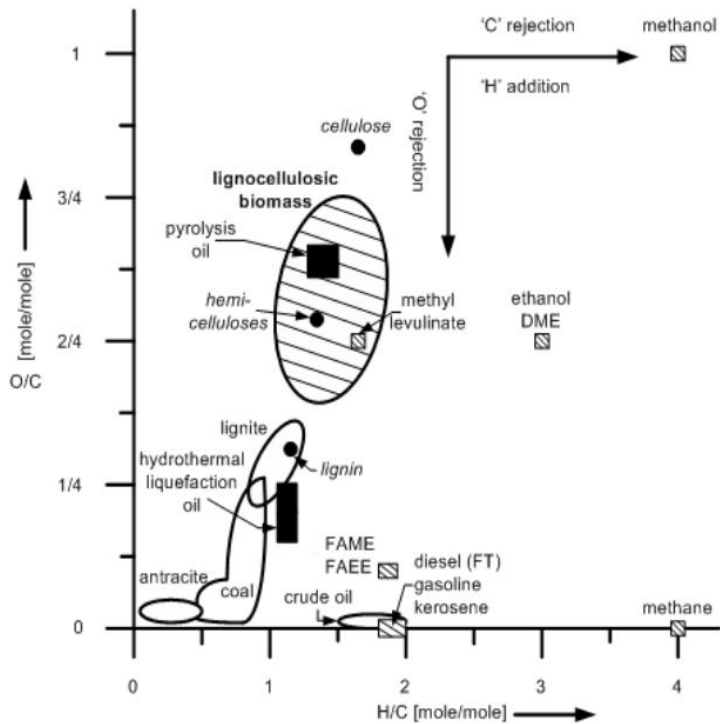

Figure 4. The Van Krevelen diagram with relevant products [45].

For the data known from literature on biomass upgrading, the Van Krevelen plot is shown in Figure 5 for a variety of catalysts, space velocities and other process conditions. The various processes referred to earlier can be clearly distinguished (solid lines). Upon the thermal treatment of the oil, the principal process seems to be the rejection of oxygen, likely in the form of water although some CO_2 is released as well. The data points obtained for the high-pressure thermal treatment of bio-oil are presented in Figure 5, and are located on the water removal curve. To obtain HDO products with the desired H/C and O/C ratios as given above, hydrogen is required.

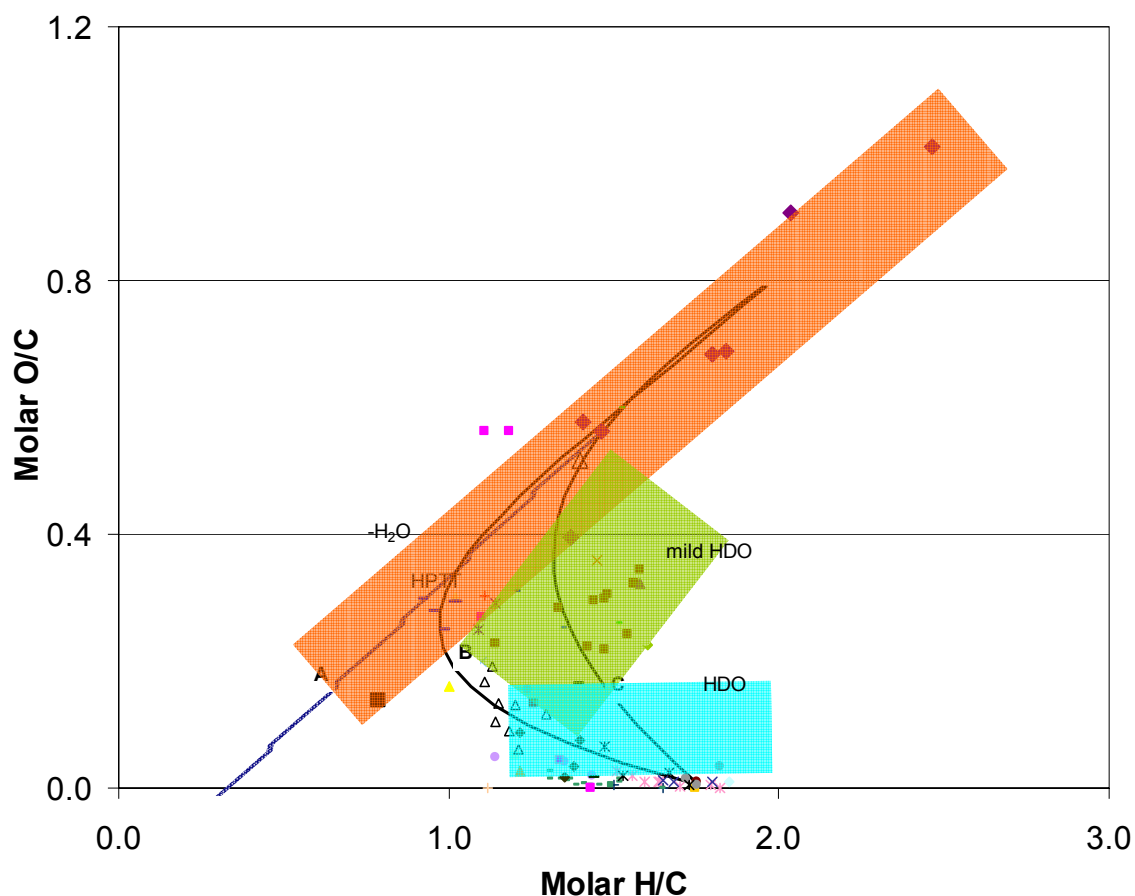

Figure 5: Van Krevelen plot interpreted in dehydration ($\text{-H}_2\text{O}$), HDO and mild HDO data from literature.

Several lines are drawn in Figure 5. To show possible hydrodeoxygenation pathways. The pathways are conceptually different from each other. To reach complete deoxygenation, either a pathway following HPTT (A) and subsequent hydrotreating can be followed, or the two-stage approach (mild hydrotreatment (B) and subsequent deep hydrogenation (C)) as described by Elliot. The choice which pathway (indicated by H_2O , mild HDO and HDO) is followed will have a significant effect on hydrogen consumption, but also on the required operating conditions.

4. Hydrogen consumption and process implications

Hydrotreating requires hydrogen, and especially in the case of a hydrogen depleted bio-oil ($\text{H/C, O/C} = (1.7, 0.6)$), a large amount of hydrogen is required to ensure sufficient

oxygen removal. Hydrogen consumption will have a large impact on the manufacturing costs of HDO products and reduction of its use is of prime interest. Based upon the bio-oil composition the following theoretical overall mass balances for the HDO of dry bio-oil can be made:

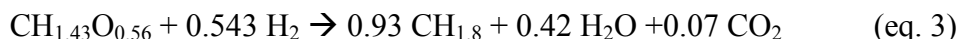

On a bio-oil weight basis up to 5 %-wt. H_2 is required, which corresponds to about 600 NL / kg bio-oil (approx. 30 % of the energetic input of the bio-oil).

Several remarks can be made here:

1. Some additional gaseous components may be formed as well, such as methane, ethane, and other C_2^+ gases: these reactions are not preferred as they consume substantial amounts of hydrogen [16].
2. In the abovementioned equation, the aromatic character of the bio-oil is maintained to minimize hydrogen consumption and to produce a higher-octane gasoline blending stock [16]. Saturation of the aromatic components in the bio-oil ($\text{H/C}=2$) is not preferred, since then much more hydrogen is required and, if a transportation fuel (and consequently crude oil additive) is aimed at, cyclic hydrocarbons have poor octane numbers.
3. For mild hydrotreatment less hydrogen is required, and the pathway to reach the desired deoxygenation level determines the exact amount of hydrogen (see Figure 6).

The latter is shown in more detail in Figure 6, which represents the lines from Figure 5: one line and two curves are depicted here, referred to as A, B and C. A represents the line where (due to e.g. temperature) all oxygen from the bio-oil is removed by removing water, either as water as an integral part of bio-oil, or as water produced by the (condensation) reactions taking place upon heating. The data-points associated with this line are those reported for the crude bio-oil, HPTT oil [36] and for charcoal. Any small

deviation from this line can be explained by the formation of small amounts of gas (CO_2 and CO). Obviously, for the removal of this oxygen, no hydrogen is required.

Then, from a certain point onwards, water removal alone is not sufficient to remove most of the oxygen, as charring of the bio-oil will occur. Hydrogen (and / or CO) is required to reduce the oxygen content further (curve B, HPTT line). The data points on this line are associated with those from the Albany hydrothermal liquefaction plant, HTU, the hydrodeoxygenation of PERC oil (also from Albany, Elliot) etc.

In another approach, depicted by curve C, the pathway of first a mild hydrotreatment and subsequent (full) hydrodeoxygenation is shown as well. Data on this line can be traced back to the bio-oil two-step approach as suggested by Elliot *et al.* [13].

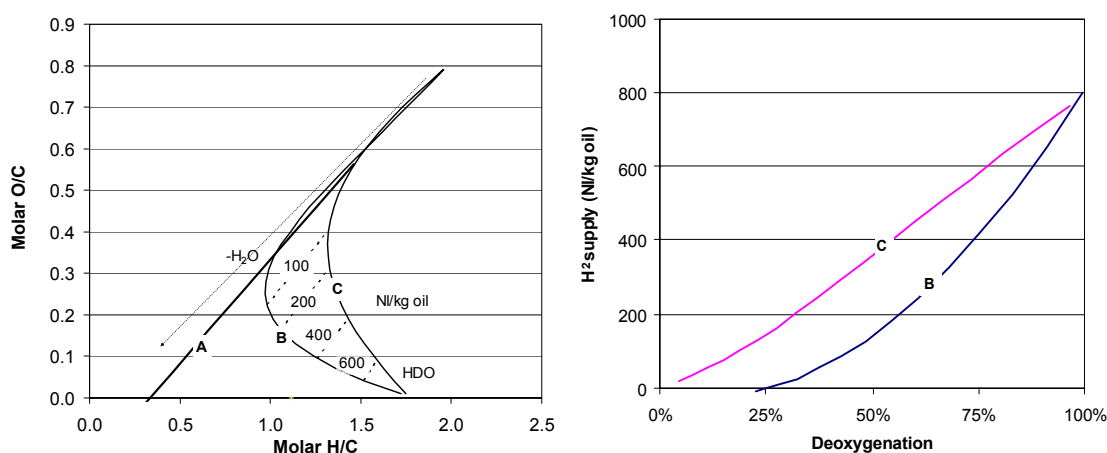

Figure 6. On the left is shown the van Krevelen diagram including the lines at different hydrogen consumption as a function of HDO severity, also included are line A water removal, B HPTT and C HDO. On the right the hydrogen consumption is shown as function of the deoxygenation with two lines C the HPTT and line B mild and deep HDO.

Obviously, the pathway to end up with partially deoxygenated oil through HPTT and subsequent hydrotreating requires less hydrogen than the pathway of mild hydrotreatment followed by full hydrodeoxygenation. The lines for similar hydrogen consumption rates are depicted in Figure 6 by dashed lines as well (100, 200, 400 and 600 NL/kg oil respectively). It shows that approx. 200 L hydrogen per kg oil results in a deoxygenation

rate of 25 % in the mild hydrotreatment step, but over 50 % if first a HPTT step is followed. A schematic presentation of the hydrogen consumption rate as a function of the deoxygenation rate is presented in Figure 6. Only for the full hydrotreatment of oil, similar hydrogen consumption rates are thus required.

The question remains though whether the HPTT derived oils can be easily hydrogenated: it seems that oils derived from HPTT are less likely to char, but need higher reaction severities than bio-oil mildly hydrotreated first. This needs to be confirmed.

5. Thesis outline

This thesis describes the results of experimental studies on the hydrotreatment of fast pyrolysis oil for the production of transportation fuels. The incentive of this research was to identify and modify the most suitable catalyst and reaction conditions for this process and to characterize and test the product as a transportation fuel.

Chapter 2 describes an experimental study on the upgrading of fast pyrolysis oil by catalytic hydrotreatment. A variety of heterogeneous noble metal catalysts have been tested for this purpose and the results are compared to typical hydrotreatment catalysts. The reactions were carried out at temperatures in the range of 250 to 350 °C and pressures between 100 and 200 bar. The Ru/C catalyst appears superior to the classical hydrotreating catalysts with respect to oil yield (up to 60 %-wt.) and deoxygenation level (up to 90 %-wt.). The upgraded products were less acidic and contained less water than the original fast pyrolysis oil. The HHV was about 40 MJ/kg, which is about twice the value of pyrolysis oil. Analyses of the products by ¹H-NMR and 2D-GC showed that the upgraded pyrolysis oil contained less organic acids, aldehydes, ketones and ethers than the feed whereas the amounts of phenolics, aromatics and alkanes were considerably higher. In a subsequent study described in **Chapter 3** the Ru/C catalyst selected in the previous study was used for the upgrading of fast pyrolysis oil using hydrogen at 350 °C and 200 bar pressure in a batch reactor set-up. The effects of reaction time on oil yield and elemental composition of each product phase was determined. The highest oil yields (65 %-wt.) were obtained after 4 h using a 5 %-wt. intake of catalyst on fast pyrolysis oil. Longer reaction times lead to a reduction of the oil yield due to the formation of gasphase components (methane, CO/CO₂). A solvent-solvent extraction procedure was applied to

gain insight in the molecular processes during the catalytic hydrotreatment experiments. It may be concluded that the carbohydrate fraction is very reactive whereas the lignin fraction remains about constant in the course of the reaction. **Chapter 4** focuses on catalyst stability of the Ru/C catalyst during the hydrotreatment of fast pyrolysis oil (350 °C and 200 bar) in a batch set-up. A considerable reduction in the liquid yield, increased solids formation, a reduction in the H/C ratio of the liquid product and a lowering of the extent of methane in the gas phase was observed after a number of catalyst recycles. Characterization of the catalyst before and after reaction using TEM, chemo- and physisorption showed significant coke deposition and a decrease in metal dispersion and pore volume. The application of in house prepared Ru/C catalysts for both the hydrotreatment of fast pyrolysis oil as well as phenol using different Ru-precursors (RuCl₃, Ru(NO₃)(NO)₃ and Ru(acac)₃) showed different effects on both product yield and elemental composition of the liquid phase. A catalyst prepared with RuCl₃ at a ruthenium loading of 5 %-wt. showed the highest activity in the hydrogenation of pyrolysis oil and the lowest decrease in BET area and dispersion. **Chapter 5** deals with the catalytic hydrotreatment of representative model components for the carbohydrate fraction (viz. D-glucose and D-cellobiose) present in concentrations of 20 to 40 % in fast pyrolysis oils. The hydrotreatment was conducted at a temperature of 250 °C and 100 bar hydrogen using Ru and Pd on carbon catalysts in water. Two parallel reaction pathways were observed, a thermal non-catalysed pathway leading to insoluble humins (char), and a hydrogenation pathway leading to smaller polyols and gaseous hydrocarbons like methane and ethane. The implications of these findings for the catalytic hydrotreatment of fast pyrolysis oil will be discussed. In the final part of the study, **Chapter 6**, a number of hydrotreated fast pyrolysis oil which were prepared in a batch autoclave (5 L) at 340 °C, 200-350 bar and analysed using a variety of techniques. The products were tested as a substitute for diesel in a stationary Hatz diesel engine. The exhaust emissions were measured and showed a higher CO content though a lower NO_x content when compared to diesel. After testing the injectors were studied visually and by SEM. Coke deposit was evident though corrosion patterns on the surface were absent.

References

- [1] Demirbas, A. Progress and Recent Trends in Biofuels. *Prog. Energy Combust.*, **2007**, 33(1), 1.
- [2] Bridgwater, A.; Czernik, S.; Diebold, J.; Meier, D.; Oasmaa, A.; Peacocke, C. *Fast Pyrolysis of Biomass: A handbook. Vol. 1*; CPL Press: Berkshire; 1999.
- [3] Bridgwater, A. *Pyrolysis and Gasification of Biomass and Waste.*, CPL Press: Newbury Berkshire, **2003**.
- [4] Meier, D.; Faix, O. State of the Art of Applied Fast Pyrolysis of Lignocellulosic Materials - a Review. *Bioreours. Technol.* **1999**, 68(1), 71.
- [5] Diebold, J. P. A Review of the Chemical and Physical Mechanisms of the Storage Stability of Fast Pyrolysis Bio-Oils. **2000**. NREL/SR-570-27613.
- [6] Oasmaa, A.; Meier, D. Norms and Standards for Fast Pyrolysis Liquids - 1. Round Robin Test. *J. Anal. Appl. Pyrolysis* **2005**, 73(2), 323.
- [7] Oasmaa, A.; Peacocke, C.; Gust, S.; Meier, D.; McLellan R. Norms and Standards for Pyrolysis Liquids. End-user Requirements and Specifications. *Energ. Fuel.* **2005**, 19(5), 2155.
- [8] Oasmaa, A.; Kuoppala, E.; Gust, S.; Solantausta, Y. Fast Pyrolysis of Forestry Residue. 1. Effect of Extractives on Phase Separation of Pyrolysis Liquids. *Energ. Fuel.* **2003**, 17(1), 1.
- [9] Oasmaa, A.; Kuoppala, E.; Solantausta, Y. Fast Pyrolysis of Forestry Residue. 2. Physicochemical Composition of Product Liquid. *Energ. Fuel.* **2003**, 17(2), 433.
- [10] Goudriaan, F.; Peferoen, D.G.R. Liquid Fuels from Biomass via A Hydrothermal Process. *Chem. Eng. Sci.* **1990**, 45(8), 2729.
- [11] Goudriaan, F.; van de Beld, B.; Boerefijn, F.R.; Bos, G.M.; Naber, J.E.; van der Wal, S.; Zeevalkink, J.A. Thermal Efficiency of the HTU Process for Biomass Liquefaction. in: Bridgwater, A.V. *Progress in Thermochemical Biomass Conversion*, vol. 2, Blackwell Science: Oxford, 2001, 1312.
- [12] Venderbosch, R. H.; Sander, C.; Tjeerdsma, B. Hydrothermal Conversion of Wet Biomass. **1999**. Utrecht, Gave Report, Novem.
- [13] Elliott, D.C.; Baker, E.G. Upgrading Biomass Liquefaction Products through Hydrodeoxygenation. *Biotechnol. Bioeng. Symp.* **1984**, suppl. 14, 159.
- [14] Elliott, D.C.; Baker, E.G. Process For Upgrading Biomass Pyrolyzates. US patent 4,795,841. **1987**.

- [15] Elliott, D.C.; Schiefelbein, G.F. Liquid-Hydrocarbon Fuels from Biomass. *Abstr. Pap. Am. Chem. Soc.* **1989**, 34, 1160.
- [16] Elliott, D.C. Historical Developments in Hydroprocessing Bio-oils. *Energ. Fuel.* **2007**, 21(3), 1792.
- [17] Sheu, Y.H.E.; Anthony, R.G.; Soltes, E.J. Kinetic-Studies of Upgrading Pine Pyrolytic Oil by Hydrotreatment. *Fuel. Process. Technol.* **1988**, 19, 31.
- [18] Wilson, N.G.; Williams, P.T. Investigation into the Potential of a Novel Superacid Catalyst for the Catalytic Upgrading of Pyrolytic Bio-oil. *Int. J. Energy Res.* **2003**; 27(2), 131.
- [19] Zhang, S.P. Study of Hydrodeoxygenation of Bio-Oil from the Fast Pyrolysis of Biomass. *Energ. Source.* **2003**, 25, 57.
- [20] Elliott D.C.; Neuenschwander, G.G. Liquid Fuels by Low-Severity Hydrotreating of Biocrude. In: Bridgwater, A.V.; Boocock, D.G.B.; editors. *Developments in Thermochemical Biomass Conversion Vol. 1.*; Blackie Academic & Professional: London, 1996, 611.
- [21] Samolada, M.C.; Baldauf, W.; Vasalos, I.A. Production of a Bio-Gasoline by Upgrading Biomass Flash Pyrolysis Liquids via Hydrogen Processing and Catalytic Cracking. *Fuel.* **1998**, 77, 1667.
- [22] Gagnon, J.; Kaliaguine, S. Catalytic Hydrotreatment of Vacuum Pyrolysis Oils from Wood. *Ind. Eng. Chem. Res.* **1988**, 27, 1783.
- [23] Wagenaar, B.M. The Rotating Cone Reactor for Rapid Thermal Solids Processing. Ph.D. Thesis, University of Twente, The Netherlands, **1994**.
- [24] Oasmaa, A.; Boocock, D.G.B. The Catalytic Hydrotreatment of Peat Pyrolysis Oils. *Can. J. Chem. Eng.* **1992**, 70, 294.
- [25] Furimsky, E.; Massoth, F.E. Deactivation of Hydroprocessing catalysts. *Catal. Today* **1999**, 52(4), 381.
- [26] Baldauf, W.; Balfanz, U.; Rupp, M. Upgrading of Flash Pyrolysis Oil and Utilization in Refineries. *Biomass. Bioeng.* **1994**, 237.
- [27] Otterstedt, J.E.; Gevert, S.B.; Jaras, S.G.; Menon, P.G. Fluid Catalytic Cracking of Heavy (Residual) Oil Fractions - A Review. *Appl. Catal.* **1986**, 22(2), 159.
- [28] Appleby, W.G.; Good, G.M.; Gibson, J.W. Coke Formation in Catalytic Cracking. *Ind. Eng. Chem. Proc. Des. Devel.* **1962**, 1(2), 102.
- [29] Furimsky, E. Catalytic hydrodeoxygenation. *Appl. Catal., A* **2000**, 199(2), 147.

- [30] Conti, L.; Scano, G.; Boufala, J.; Mascia, S. Experiments of Bio-oil Hydrotreating in a Continuous Bench-Scale Plant. In: Bridgwater, A.V.; Hogan, E.N., editors. *Bio-Oil Production and Utilization*. CPL Press, Newbury Berks, **1996**, 198.
- [31] Laurent, E.; Delmon, B. Study of the Hydrodeoxygenation of Carbonyl, Carboxylic and Guaiacyl Groups Over Sulphided Como/Gamma-Al₂O₃ and Nimo/Gamma-Al₂O₃ Catalyst .2. Influence of Water, Ammonia and Hydrogen-Sulfide. *Appl. Catal. ,A* **1994**, 109(1), 97.
- [32] Centeno, A.; Laurent, E.; Delmon, B. Influence of the Support of Como Sulfide Catalysts and of the Addition of Potassium and Platinum on the Catalytic Performances for the Hydrodeoxygenation of Carbonyl, Carboxyl, and Guaiacol-Type Molecules. *J. Catal.* **1995**, 154(2), 288.
- [33] Furimsky, E. The Mechanism of Catalytic Hydrodeoxygenation of Furan. *Appl. Catal.* **1983**, 6(2), 159.
- [34] Scholze, B. Long-term Stability, Catalytic Upgrading, and Application of Pyrolysis Oils - Improving the Properties of a Potential Substitute for Fossil Fuels. PhD thesis, University of Hamburg, **2002**.
- [35] Wildschut, J.; Heeres, H. J. Experimental studies on the upgrading of fast pyrolysis oil to liquid transportation fuels. *Prepr. Pap. - Am. Chem. Soc., Div. Fuel Chem.* **2008**, 53(1), 349.
- [36] Rep, M.; Venderbosch, R.H.; Assink, D.; Tromp, W.; Kersten, S.R.A.; Prins, W. *et al.* De-oxygenation of Bio-oils. In: Bridgwater, A.V.; Boocock, D.G.B.; editors. *Science in Thermal and Chemical Biomass Conversion*. Chippenham: CPL Press: Newbury Berkshire, 2006.
- [37] Kaiser, M. Final Report: Demonstration of Bio-Oil Upgrading by Hydrogenation. Contract AIR1-CT92-0216 Supplementary Agreement No.2. **1997**.
- [38] Furimsky, E. Thermochemical and Mechanistic Aspects of Removal of Sulfur, Nitrogen and Oxygen from Petroleum. *Kohle Erdgas P.* **1983**, 36(11), 518.
- [39] Zhang, S.; Yan, Y.; Li, T.; Ren, Z. Upgrading of Liquid Fuel from the Pyrolysis of Biomass. *Bioresour. Technol.* **2005**, 96, 545.
- [40] Churin, E.; Grange, P.; Delmon, B. Upgrading of Bio-Oils by Hydrotreatments. *Abstr. Pap. Am. Chem. Soc.* **1987**, 193, 65.
- [41] Rust International Corporation. An Investigation of Liquefaction of Wood: Final Report. prepared under subcontract to PNL, DOE/NBM-1060. **1983**.
- [42] Sheu, Y.H.E.; Philip, C.V.; Anthony, R.G.; Soltes, E.J. Separation of Functionalities in Pyrolytic Tar by Gel-Permeation Chromatography Gas-Chromatography. *J. Chrom. Sci.* **1984**, 22(11), 497.

- [43] Oasmaa, A. Fuel Oil Quality Properties of Wood Based Pyrolysis Liquids. PhD thesis, University of Jyväskylä, Finland **2003**.
- [44] Van Krevelen, D.W. Graphical Statistical Method for the Study of Structure and Reaction Processes of Coal. *Fuel*. **1950**, 29, 269.
- [45] Kersten, S.R.A.; van Swaaij, W.P.M.; Lefferts, L.; Seshan, K. Options for Catalysis in the Thermochemical Conversion of Biomass into Fuels in: Centi, G.; van Santen, R.A., editors, *Catalysis for Renewables: from feedstock to Energy Production.*, Wiley-VCH: Chichester, **2007**.

